

Flower Tower rm240s

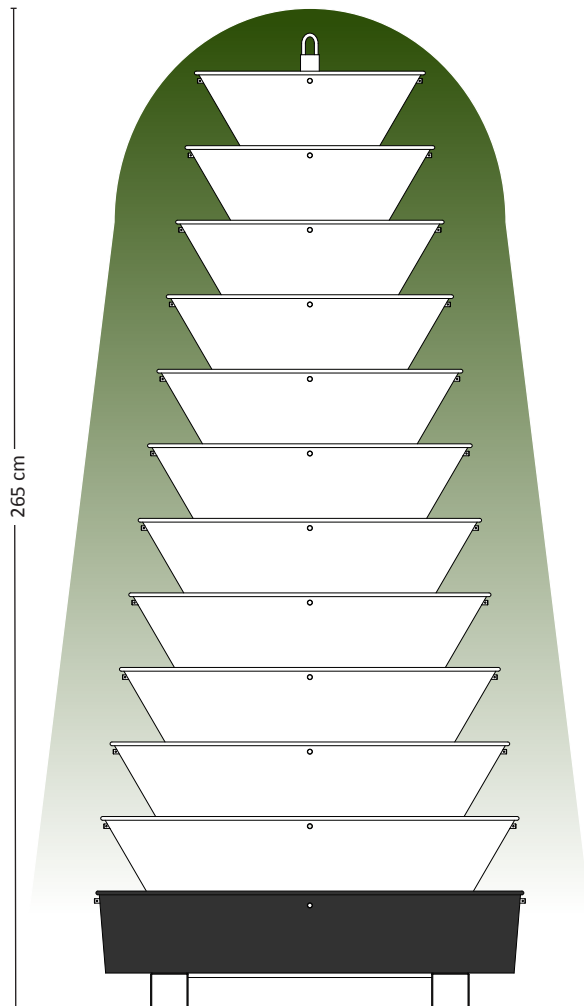

115 cm

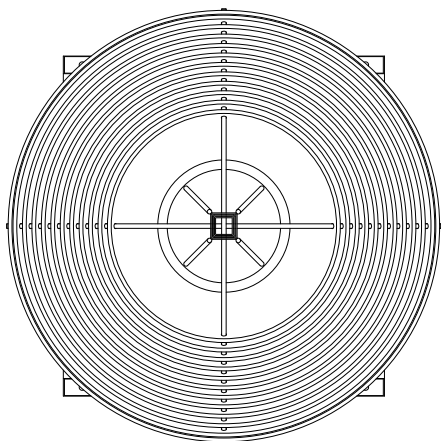

Flower Tower rm240s

- **Base:** hot rolled steel + duplex finish (galvanized + powder coated)
- **Rings:** galvanized steel, spun in one piece
- **Central pole and rods:** galvanized steel
- **Moveable** with pallet jack and forklift
- 1,45m³ of substrate (8,3 liter / plant)
- 175 plants (pro rata of 5 plants per linear meter)
- 1,3m² of floor space exposes 6,5 m² of flowers
- Weight (empty): 150 kg